

ELLIPSOIDAL LIGHTING

Catalog Numbers

- 3.5Q* - 5 - MT 3.5Q* - 10 - MT
- 3.5Q* - 6 - MT 3.5Q* - 12 - MT
- 3.5Q* - 8 - MT

Fixture Type:

**Discontinued
January 2022**



A compact, lightweight ellipsoidal spotlight which produces a high intensity sharp or soft edged beam. The 3.5Q series is designed for today's long life, high intensity tungsten halogen lamps up to 575W. Four adjustable integral stainless steel framing shutters provide beam shaping ability and the pattern slot and holder provide the ability to project visual images. The 3.5Q is available in portable and Smart Track™ versions, and is compatible with Altman Lighting's STD-600 yoke mounted DMX dimmer,

While primarily designed for theatre and studio applications, the 3.5Q Series is also useful in displays, show windows, museums and nightclubs where precision controlled accenting is desirable.

Specifications subject to change without notice.

Features:

- Compatible with GL Series 375w and 575w compact filament lamps.
- Heat resisting plano convex lenses
- Aluminum die cast and sheet metal construction
- Axially mounted medium two-pin socket
- Double flatted specular Alzak aluminum reflector
- Tool free interchangeable lens barrels
- Three 36" Teflon lead wires
- Smart Track™ version available with integrated dimmer
- Pipe mount version compatible with optional STD-600 yoke mounted DMX dimmer
- Up to 25' of Hi-Temp rubber cable optional
- Color frame and safety cable with spring clip included
- ETL listed for 575 watts

3.5Q FIELD ANGLES

Model	Field
3.5Q-5-MT	48°
3.5Q-6-MT	38°
3.5Q-8-MT	28°
3.5Q-10-MT	23°
3.5Q-12-MT	18°

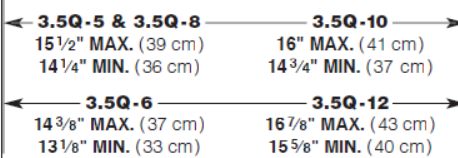
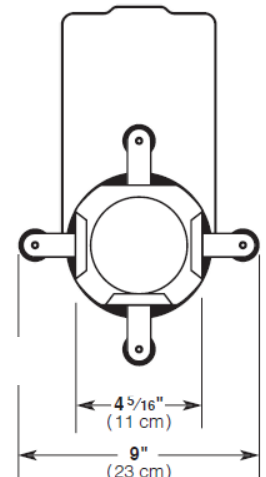
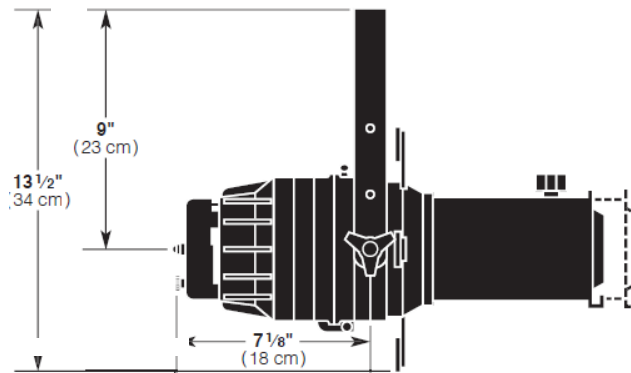

575 WATT 3.5Q ELLIPSOIDAL

ELLIPSOIDAL LIGHTING

Specifications:

Housing: Die-cast aluminum and sheet steel construction.

Materials: Construction employs all corrosion-resistant materials and hardware.

Yoke: Rigid flat steel with dual handles.

Reflector: Alzak aluminum, ellipsoidal design.

Lenses: Pyrex glass.

Socket: Altman BPS-1200 medium two-pin, axially mounted with blinder/heat shield, tool free relamping.

Rating: 120/240 volts AC/DC operation, 4.8/2.4 amps, 575 watts maximum.

Cable: 36" Teflon leads encased in black fiberglass sleeving. Hi-Temp rubber cable optional, up to 25'.

Shutters: Four provided, stainless steel, fully adjustable. Handles provided with heat resistant knobs.

Access Door: Hinged, removable without tools, allowing access to lens and reflector.

Focusing Lamp: Fully adjustable.

Focusing Fixture: Lens movement adjustable with locking heat resistant knob.

Accessories: Accepts drop-in pattern holder and standard 4 1/8" accessories.

Color Frame Size: 4 1/8" x 4 1/8"

Pattern Size: Accepts Metal Patterns 2-5/16" Diameter with 1-7/8" Diameter Image Size

Finish: Black epoxy sandtex electrostatic application. White, Silver, and custom paint finished available.

Weight: Approx; 9 lbs. (4.8kg.)

**Discontinued
January 2022**

3.5Q* - 5 - MT

3.5Q* - 6 - MT

3.5Q* - 8 - MT

Catalog Numbers

3.5Q* - 10 - MT

3.5Q* - 12 - MT

Part Number: 3.5(Q/QX/QY/QXY)*-**-MT-***			
	Model*	Lens**	Color***
Standard	3.5Q**-MT-***	5 (48°)	BK (Black)
Standard w/Speed Cap	3.5QSC**-MT-***	6 (38°)	WH (White)
Smart Track™	3.5QY**-MT-***	8 (28°)	SL (Silver)
Smart Track™ w/Speed Cap	3.5QSCY**-MT-***	10 (23°)	C (Custom)
		12 (18°)	

Accessories included with 3.5Q	
3.5Q-CF	Color Frame 4-1/8"x4-1/8" (Specify BK/WH/SL)
SC-36-BK	Black Safety Cable with Spring Clip

Additional Accessories	
TLA-TEK100-*	TEK 2-Circuit Track Adapter (Standard Fixture Only) (Black/ White/ or Silver)
510	Malleable Iron Pipe Clamp for 3/4"-1-1/2" Pipe
3.5Q-DN	4-1/8"x4-1/8" Donut, Black, w/ 1-1/4" Hole
3.5Q-PH	Pattern Holder, Black, 2" Dia. Opening (steel patterns)
3.5Q-SN	Snoot, Black
71-1015	Replacement Easy Focusing Speed Cap
STD-600	600w Smart Theatrical Dimmer w/Yoke Mount Kit

LAMP DATA

Fixture Series	Watts	ANSI Code	Color Temp (°K)	Rated Life (hours)	Rated Lumens	Correction Factor
3.5Q	375	GLH	2,900	1,500	8,000	X0.8
	375	GLG	3,250	300	10,000	X1.00
	500	EHD	3,000	2,000	10,000	X1.00
	575	GLC	3,250	300	15,500	X1.55
	575	GLA	3,100	1,500	13,500	X1.35

575 WATT 3.5Q ELLIPSOIDAL

Photometrics:

ELLIPSOIDAL LIGHTING

Catalog Numbers

**Discontinued
January 2022**

3.5Q* - 5 - MT

3.5Q* - 10 - MT

3.5Q* - 6 - MT

3.5Q* - 12 - MT

3.5Q* - 8 - MT

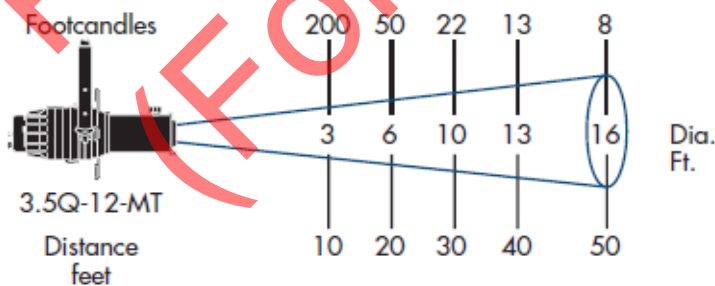
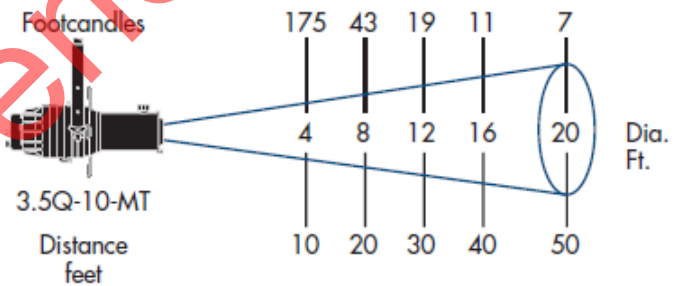
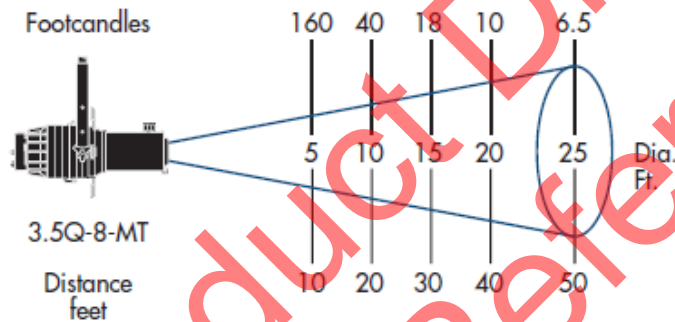
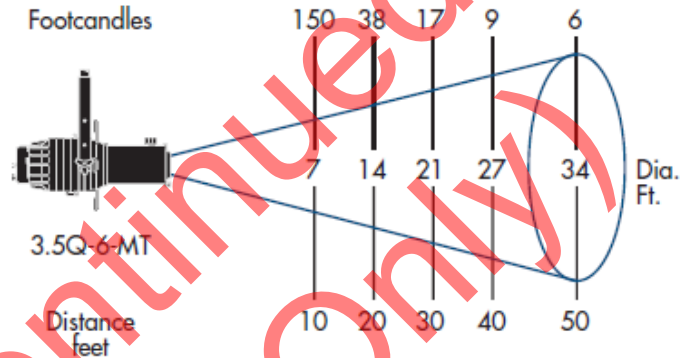
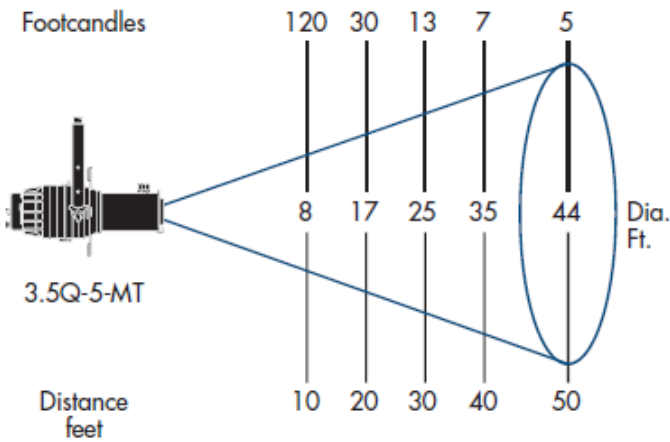

3.5Q PERFORMANCE CHART WITH EHD LAMP

Fixture Series	Candelpower (cd)	Beam Angle (Deg)	Field Angle (Deg)	Efficiency (%)
3.5Q-5-MT	12,000	30°	48°	29.0
3.5Q-6-MT	15,000	21°	38°	24.0
3.5Q-8-MT	16,000	21°	28°	18.5
3.5Q-10-MT	17,300	21°	23°	17.0
3.5Q-12-MT	20,000	17°	18°	12.0